

# CHO-SORB<sup>®</sup> EMI Attenuators

Reduce radiated emissions on data and power cables without affecting data transmission.

## Customer Value

### Proposition:

Cost effective CHO-SORB EMI ferrites reduce radiated emissions on signal lines and power cables without affecting data transmission. Parker Chomerics CHO-SORB attenuators are made of specially formulated soft ferrite material, which is a chemical composition of various metallic oxides, primarily nickel zinc. They possess two principle characteristics useful for controlling emissions: high magnetic permeability, which concentrates magnetic fields, and high electrical resistivity, which limits the flow of electrical current in the field. The properties of CHO-SORB ferrite materials can be found in Table 1. CHO-SORB ferrite attenuators allow desired signals to pass through cables or circuits while absorbing extraneous and unwanted energy. Low frequency and DC see only the conductor and are unimpeded. High frequency energy couples with the CHO-SORB attenuator, creating an impedance with inductive and resistive qualities. When a radiating conductor is surrounded by a ferrite attenuator, low frequency signals are transmitted without any loss. High frequency signals encounter inductive resistance due to the ferrite material's permeability. This resistance reduces the conducted current and introduces an insertion loss. At still higher frequencies, the permeability of the ferrite material decreases and the inductive resistance falls. Here, the resistive characteristics dominate and the resistive quality of the ferrite assumes control of providing the insertion loss for dissipating EMI.

### Contact Information:

Parker Hannifin Corporation  
**Chomerics Division**  
77 Dragon Court  
Woburn, MA 01801

phone 781 935 4850  
fax 781 933 4318  
chomailbox@parker.com

www.chomerics.com  
www.parker.com/chomerics



### Product Features:

- Reduce EMI for compliance with FCC, EC, VDE, and CISPR 22 limits.
- Reduce susceptibility to ESD
- Easy installation
- No grounding required, unlike cable shields
- Will not affect data transmitted, as can filter pin connectors
- Cost effective

### Applications:

- CHO-SORB ferrite attenuators effectively reduce EMI on cables and signal lines and are utilized on the following types of equipment:
- Computers, Printers, Keyboards
- PBXs and CATVs
- Radio and Television Receivers
- Medical Electronic Systems
- Data Communications Equipment



ENGINEERING YOUR SUCCESS.

# CHO-SORB® - Product Information

Table 1

TYPICAL PROPERTIES		
Property	Units	83-10-XXXX-1000
Material	--	Nickel Zinc
Initial Permeability @ B < 10 Gauss, $\mu_1$	--	850
Flux Density @ (B) @ 10 Oersteds	Gauss	2750
Residual Flux Density	Gauss	1200
Loss Factor ( $\tan/\mu_1$ )	--	$120 \times 10^{-6}$ @ 1 MHz
Curie Temperature	°C	>130
Volume Resistivity	ohm-cm	$10^5$
Temperature Coefficient of $\mu_1$ (20-70°C)	%/°C	1.0
Recommended Frequency Range	MHz	30-200

## Ordering Procedure:

Standard CHO-SORB cable ferrites are featured on the following pages. All configurations, including attachment clamps, are available through authorized Chomerics distributors for quick, off-the-shelf delivery.

**Figure 1**  
**SLEEVE BEADS**  
sorted by "A" dimension

Impedance-Frequency Characteristics  
P/N 83-10-M460-1000

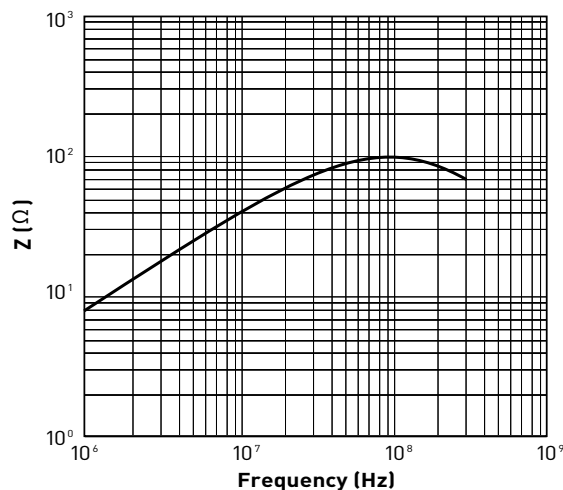
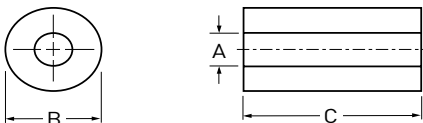

Table 2

Part Number	DIMENSIONS - inches (mm)			IMPEDANCE (ohms)*	
	A (I.D.)	B (O.D.)	C (Length)	@ 25 MHz ±20%	@ 100 MHz ±20%
83-10-M12886-1000	0.032±0.006 (0.80±0.15)	0.098±0.006 (2.50±0.15)	0.158±0.012 (4.00±0.30)	33	52
83-10-M12887-1000	0.032±0.006 (0.80±0.15)	0.138±0.006 (3.50±0.15)	0.552±0.016 (14.00±0.40)	144	21
83-10-M12888-1000	0.032±0.006 (0.80±0.15)	0.386±0.012 (9.80±0.30)	0.449±0.016 (11.40±0.40)	167	256
83-10-M12889-1000	0.040±0.006 (1.00±0.15)	0.119±0.006 (3.00±0.15)	0.119±0.008 (3.00±0.20)	25	47
83-10-M12890-1000	0.040±0.006 (1.00±0.15)	0.138±0.006 (3.50±0.15)	0.315±0.012 (8.00±0.30)	78	111
83-10-M12891-1000	0.048±0.006 (1.00±0.15)	0.119±0.006 (3.00±0.15)	0.119±0.008 (3.00±0.20)	23	44

\*Based upon single turn impedance measurement, using an HP 4193A

# CHO-SORB® - Product Information

Table 2 continued

Part Number	DIMENSIONS - inches (mm)			IMPEDANCE (ohms)*	
	A (I.D.)	B (O.D.)	C (Length)	@ 25 MHz ±20%	@ 100 MHz ±20%
83-10-M12892-1000	0.048±0.006 (1.20±0.15)	0.138±0.006 (3.50±0.15)	0.158±0.012 (4.00±0.30)	31	46
83-10-M12893-1000	0.048±0.006 (1.20±0.15)	0.138±0.006 (3.50±0.15)	0.197±0.012 (5.00±0.30)	37	55
83-10-M12894-1000	0.048±0.006 (1.20±0.15)	0.138±0.006 (3.50±0.15)	0.237±0.012 (6.00±0.30)	45	73
83-10-M12895-1000	0.048±0.006 (1.20±0.15)	0.138±0.006 (3.50±0.15)	0.276±0.012 (7.00±0.30)	54	84
83-10-M12896-1000	0.052±0.006 (1.30±0.15)	0.138±0.006 (3.50±0.15)	0.197±0.012 (5.00±0.30)	37	61
83-10-M516-1000	0.052±0.006 (1.30±0.15)	0.138±0.006 (3.50±0.15)	0.237±0.012 (6.00±0.30)	42	72
83-10-M12897-1000	0.052±0.006 (1.30±0.15)	0.138±0.006 (3.50±0.15)	0.355±0.012 (9.00±0.30)	62	80
83-10-M442-1000	0.052±0.004 (1.30±0.15)	0.139±0.008 (3.50±0.20)	0.128±0.010 (3.25±0.25)	27	44
83-10-M12898-1000	0.060±0.006 (1.50±0.15)	0.138±0.006 (3.50±0.15)	0.237±0.012 (6.00±0.30)	35	60
83-10-M12899-1000	0.060±0.006 (1.50±0.15)	0.197±0.008 (5.00±0.20)	0.434±0.016 (11.00±0.40)	93	150
83-10-M492-1000	0.062±0.006 (1.57±0.15)	0.200±0.008 (5.00±0.20)	0.438±0.016 (11.10±0.40)	93	148
83-10-M12839-1000	0.071±0.006 (1.80±0.15)	0.138±0.006 (3.50±0.15)	0.197±0.012 (5.00±0.30)	27	48
83-10-M12787-1000	0.079±0.006 (2.00±0.15)	0.158±0.008 (4.00±0.20)	0.079±0.006 (2.00±0.15)	14	37
83-10-M12901-1000	0.079±0.006 (2.00±0.15)	0.158±0.008 (4.00±0.20)	0.158±0.012 (4.00±0.30)	24	48
83-10-M12902-1000	0.079±0.006 (2.00±0.15)	0.158±0.008 (4.00±0.20)	0.197±0.012 (5.00±0.30)	28	51
83-10-M12903-1000	0.079±0.006 (2.00±0.15)	0.158±0.008 (4.00±0.20)	0.276±0.012 (7.00±0.30)	40	64
83-10-M12779-1000	0.079±0.006 (2.00±0.15)	0.158±0.008 (4.00±0.20)	0.394±0.016 (10.00±0.40)	53	80
83-10-M12904-1000	0.085±0.006 (2.15±0.15)	0.197±0.008 (5.00±0.20)	0.709±0.016 (18.00±0.40)	128	147
83-10-M12905-1000	0.091±0.006 (2.29±0.15)	0.191±0.008 (4.80±0.20)	0.250±0.012 (6.35±0.30)	43	80
83-10-M12906-1000	0.091±0.006 (2.30±0.15)	0.197±0.008 (5.00±0.20)	0.197±0.012 (5.00±0.30)	30	55
83-10-M460-1000	0.095±0.006 (2.40±0.15)	0.296±0.008 (7.50±0.20)	0.296±0.012 (7.50±0.30)	60	102
83-10-M12907-1000	0.103±0.006 (2.60±0.15)	0.178±0.008 (4.50±0.20)	0.473±0.016 (12.00±0.40)	49	72
83-10-M12908-1000	0.119±0.008 (3.00±0.20)	0.237±0.008 (6.00±0.20)	0.394±0.016 (10.00±0.40)	52	90
83-10-M12909-1000	0.119±0.008 (3.00±0.20)	0.312±0.008 (7.90±0.20)	0.394±0.016 (10.00±0.40)	68	79
83-10-M12910-1000	0.119±0.008 (3.00±0.20)	0.312±0.008 (7.90±0.20)	0.749±0.016 (19.00±0.40)	130	190
83-10-M12911-1000	0.125±0.008 (3.15±0.20)	0.237±0.008 (6.00±0.20)	0.709±0.016 (18.00±0.40)	100	155
83-10-M12912-1000	0.126±0.008 (3.18±0.20)	0.315±0.008 (8.00±0.20)	0.397±0.016 (10.06±0.40)	67	115
83-10-M12913-1000	0.130±0.008 (3.30±0.20)	0.250±0.008 (6.35±0.20)	0.500±0.016 (12.70±0.40)	67	105
83-10-M12914-1000	0.130±0.008 (3.30±0.20)	0.250±0.008 (6.35±0.20)	0.623±0.016 (15.80±0.40)	76	125
83-10-M12915-1000	0.138±0.008 (3.50±0.20)	0.473±0.012 (12.00±0.30)	0.906±0.020 (23.00±0.50)	210	328
83-10-M12916-1000	0.158±0.008 (4.00±0.20)	0.312±0.008 (7.90±0.20)	0.504±0.016 (12.80±0.40)	66	107
83-10-M12788-1000	0.158±0.008 (4.00±0.20)	0.315±0.012 (8.00±0.30)	0.158±0.008 (4.00±0.20)	23	46
83-10-M12917-1000	0.170±0.008 (4.30±0.20)	0.256±0.008 (6.50±0.20)	0.394±0.016 (10.00±0.40)	34	62
83-10-M12918-1000	0.170±0.008 (4.30±0.20)	0.453±0.012 (11.50±0.30)	0.788±0.020 (20.00±0.50)	148	210
83-10-M12919-1000	0.170±0.008 (4.30±0.20)	0.453±0.012 (11.50±0.30)	1.024±0.024 (26.00±0.60)	190	270
83-10-M12920-1000	0.178±0.010 (4.50±0.25)	0.367±0.012 (9.30±0.30)	0.375±0.012 (9.50±0.30)	53	98
83-10-M12921-1000	0.193±0.008 (4.88±0.20)	0.486±0.012 (12.30±0.30)	1.000±0.024 (25.40±0.60)	172	264
83-10-M12789-1000	0.197±0.008 (5.00±0.20)	0.355±0.012 (9.00±0.30)	0.119±0.010 (3.00±0.25)	21	54
83-10-M245-1000	0.197±0.010 (5.00±0.25)	0.375±0.012 (9.50±0.30)	0.410±0.016 (10.40±0.40)	53	81

\*Based upon single turn impedance measurement, using an HP 4193A

# CHO-SORB® - Product Information

Table 2 continued

Part Number	DIMENSIONS - inches (mm)			IMPEDANCE (ohms)*	
	A (I.D.)	B (O.D.)	C (Length)	@ 25 MHz ±20%	@ 100 MHz ±20%
83-10-M446-1000	0.197±0.010 (5.00±0.25)	0.375±0.012 (9.50±0.30)	0.571±0.016 (14.50±0.40)	75	121
83-10-M445-1000	0.197±0.010 (5.00±0.25)	0.375±0.012 (9.50±0.30)	0.626±0.016 (15.88±0.40)	74	103
83-10-M454-1000	0.197±0.010 (5.00±0.25)	0.375±0.012 (9.50±0.30)	0.749±0.016 (19.00±0.40)	9	135
83-10-M12923-1000	0.197±0.010 (5.00±0.25)	0.375±0.012 (9.50±0.30)	0.768±0.016 (19.50±0.40)	98	153
83-10-M828-1000	0.197±0.008 (5.00±0.20)	0.380±0.010 (9.65±0.25)	0.191±0.018 (4.83±0.45)	25	47
83-10-M12924-1000	0.197±0.008 (5.00±0.20)	0.394±0.012 (10.00±0.30)	0.394±0.016 (10.00±0.40)	54	85
83-10-M12925-1000	0.197±0.010 (5.00±0.25)	0.434±0.012 (11.00±0.30)	0.729±0.016 (18.50±0.40)	113	178
83-10-M12926-1000	0.197±0.010 (5.00±0.25)	0.434±0.012 (11.00±0.30)	0.985±0.024 (25.00±0.60)	145	230
83-10-M12927-1000	0.205±0.010 (5.20±0.25)	0.375±0.012 (9.50±0.30)	0.375±0.012 (9.50±0.30)	45	76
83-10-M12928-1000	0.205±0.010 (5.20±0.25)	0.375±0.012 (9.50±0.30)	0.394±0.016 (10.00±0.40)	48	74
83-10-M12853-1000	0.217±0.010 (5.50±0.25)	0.414±0.012 (10.50±0.30)	0.788±0.020 (20.00±0.50)	95	135
83-10-M12780-1000	0.221±0.010 (5.60±0.25)	0.473±0.012 (12.00±0.30)	0.788±0.020 (20.00±0.50)	119	175
83-10-M12929-1000	0.221±0.010 (5.60±0.25)	0.473±0.012 (12.00±0.30)	1.182±0.028 (30.00±0.70)	180	260
83-10-M12930-1000	0.229±0.010 (5.80±0.25)	0.375±0.012 (9.50±0.30)	0.394±0.016 (10.00±0.40)	38	68
83-10-M12931-1000	0.229±0.010 (5.80±0.25)	0.749±0.020 (19.00±0.50)	1.241±0.032 (31.50±0.80)	291	423
83-10-M12932-1000	0.237±0.012 (6.00±0.30)	0.315±0.008 (8.00±0.20)	0.386±0.012 (9.80±0.30)	35	55
83-10-M12933-1000	0.237±0.012 (6.00±0.30)	0.394±0.012 (10.00±0.30)	0.394±0.016 (10.00±0.40)	38	66
83-10-M12934-1000	0.237±0.012 (6.00±0.30)	0.394±0.012 (10.00±0.30)	0.552±0.016 (14.00±0.40)	45	73
83-10-M12790-1000	0.237±0.008 (6.00±0.20)	0.473±0.012 (12.00±0.30)	0.158±0.012 (4.00±0.30)	24	47
83-10-M12935-1000	0.250±0.012 (6.35±0.30)	0.560±0.016 (14.20±0.40)	0.591±0.016 (15.00±0.40)	92	146
83-10-M246-1000	0.250±0.012 (6.35±0.30)	0.560±0.016 (14.20±0.40)	1.123±0.024 (28.50±0.60)	164	255
83-10-M12936-1000	0.264±0.012 (6.70±0.30)	0.386±0.012 (9.80±0.30)	0.532±0.016 (13.50±0.40)	43	91
83-10-M12937-1000	0.276±0.012 (6.99±0.30)	0.591±0.016 (14.99±0.40)	0.749±0.016 (19.00±0.40)	107	171
83-10-M12823-1000	0.276±0.012 (6.99±0.30)	0.591±0.016 (14.99±0.40)	1.100±0.016 (27.94±0.40)	151	237
83-10-M636-1000	0.276±0.012 (6.99±0.30)	0.617±0.016 (15.65±0.40)	1.125±0.024 (28.57±0.60)	164	258
83-10-M12939-1000	0.276±0.012 (7.00±0.30)	0.394±0.012 (10.00±0.30)	0.394±0.016 (10.00±0.40)	31	57
83-10-M12940-1000	0.276±0.012 (7.00±0.30)	0.473±0.012 (12.00±0.30)	0.591±0.016 (15.00±0.40)	60	92
83-10-M12941-1000	0.276±0.012 (7.00±0.30)	0.560±0.016 (14.20±0.40)	0.591±0.016 (15.00±0.40)	78	116
83-10-M12942-1000	0.276±0.012 (7.00±0.30)	0.560±0.016 (14.20±0.40)	0.926±0.020 (23.50±0.50)	127	204
83-10-M12781-1000	0.276±0.012 (7.00±0.30)	0.560±0.016 (14.20±0.40)	1.123±0.024 (28.50±0.60)	143	243
83-10-M12784-1000	0.276±0.012 (7.00±0.30)	0.630±0.016 (16.00±0.40)	1.103±0.024 (28.00±0.60)	174	247
83-10-M12782-1000	0.310±0.012 (7.87±0.30)	0.626±0.016 (15.80±0.40)	1.125±0.024 (28.57±0.60)	148	241
83-10-M12943-1000	0.312±0.012 (7.90±0.30)	0.623±0.016 (15.80±0.40)	0.630±0.016 (16.00±0.40)	74	117
83-10-M827-1000	0.312±0.010 (7.92±0.25)	0.626±0.030 (15.80±0.75)	0.562±0.014 (14.27±0.35)	79	121
83-10-M12791-1000	0.315±0.012 (8.00±0.30)	0.493±0.012 (12.50±0.30)	0.250±0.012 (6.35±0.30)	27	52
83-10-12819-1000	0.315±0.012 (8.00±0.30)	0.493±0.012 (12.50±0.30)	0.493±0.016 (12.50±0.40)	42	72
83-10-M12945-1000	0.315±0.012 (8.00±0.30)	0.560±0.016 (14.20±0.40)	0.591±0.016 (15.00±0.40)	63	107

\*Based upon single turn impedance measurement, using an HP 4193A

# CHO-SORB® - Product Information

Table 2 continued

Part Number	DIMENSIONS - inches (mm)			IMPEDANCE (ohms)*	
	A (I.D.)	B (O.D.)	C (Length)	@ 25 MHz ±20%	@ 100 MHz ±20%
83-10-M12864-1000	0.315±0.012 (8.00±0.30)	0.560±0.016 (14.20±0.40)	1.123±0.024 (28.50±0.60)	128	195
83-10-M12947-100	0.315±0.012 (8.00±0.30)	0.601±0.016 (15.25±0.40)	1.103±0.024 (28.00±0.60)	122	180
83-10-M12793-1000	0.323±0.010 (8.20±0.25)	0.650±0.012 (16.50±0.30)	0.630±0.016 (16.00±0.40)	87	145
83-10-M12871-1000	0.327±0.012 (8.30±0.30)	0.689±0.016 (17.50±0.40)	1.123±0.024 (28.50±0.60)	148	242
83-10-M12948-1000	0.335±0.012 (8.50±0.30)	0.473±0.012 (12.00±0.30)	0.591±0.016 (15.00±0.40)	45	85
83-10-M12840-1000	0.345±0.012 (8.76±0.30)	0.673±0.016 (17.00±0.40)	1.000±0.024 (25.40±0.60)	122	180
83-10-M12783-1000	0.355±0.012 (9.00±0.30)	0.630±0.016 (16.00±0.40)	0.670±0.016 (17.00±0.40)	61	115
83-10-M12949-1000	0.355±0.012 (9.00±0.30)	0.630±0.016 (16.00±0.40)	0.788±0.020 (20.00±0.50)	98	124
83-10-M12785-1000	0.355±0.012 (9.00±0.30)	0.630±0.016 (16.00±0.40)	1.103±0.024 (28.00±0.60)	104	178
83-10-M12950-1000	0.355±0.012 (9.00±0.30)	0.630±0.016 (16.00±0.40)	1.123±0.024 (28.50±0.60)	105	195
83-10-M12794-1000	0.375±0.012 (9.50±0.30)	0.689±0.016 (17.50±0.40)	0.250±0.012 (6.35±0.30)	31	53
83-10-M248-1000	0.375±0.012 (9.50±0.30)	0.689±0.016 (17.50±0.40)	1.123±0.024 (28.50±0.60)	115	170
83-10-M12951-100	0.375±0.012 (9.50±0.30)	0.689±0.016 (17.50±0.40)	1.378±0.032 (35.00±0.80)	152	253
83-10-M12952-1000	0.394±0.016 (10.00±0.40)	0.601±0.016 (15.25±0.40)	1.123±0.024 (28.50±0.60)	81	128
83-10-M12953-1000	0.394±0.016 (10.00±0.40)	0.630±0.016 (16.00±0.40)	1.103±0.024 (28.00±0.60)	91	156
83-10-M12954-1000	0.394±0.016 (10.00±0.40)	0.689±0.016 (17.50±0.40)	1.575±0.036 (40.00±0.90)	123	232
83-10-M12795-1000	0.394±0.012 (10.00±0.40)	0.709±0.016 (18.00±0.40)	0.394±0.012 (10.00±0.30)	47	77
83-10-M12955-1000	0.394±0.016 (10.00±0.40)	0.709±0.020 (18.00±0.50)	1.103±0.024 (28.00±0.60)	124	209
83-10-M12956-1000	0.394±0.016 (10.00±0.40)	0.709±0.020 (18.00±0.50)	1.142±0.024 (29.00±0.60)	128	210
83-10-M12957-1000	0.400±0.016 (10.16±0.40)	0.733±0.020 (18.60±0.50)	0.985±0.024 (25.00±0.60)	115	178
83-10-M249-1000	0.400±0.016 (10.16±0.40)	0.736±0.020 (18.60±0.50)	1.125±0.024 (28.57±0.60)	126	201
83-10-M12796-1000	0.402±0.016 (10.20±0.40)	0.808±0.020 (20.50±0.50)	0.394±0.012 (10.00±0.30)	53	86
83-10-M12792-1000	0.414±0.012 (10.50±0.30)	0.591±0.012 (15.00±0.30)	0.473±0.012 (12.00±0.30)	37	62
83-10-M12820-1000	0.422±0.016 (10.70±0.40)	0.689±0.016 (17.50±0.40)	1.123±0.024 (28.50±0.60)	90	150
83-10-M250-1000	0.506±0.016 (12.83±0.40)	1.021±0.019 (25.90±0.46)	1.125±0.030 (28.57±0.76)	127	195
83-10-M12958-1000	0.512±0.016 (13.00±0.40)	0.749±0.020 (19.00±0.50)	1.142±0.024 (29.00±0.60)	60	105
83-10-M12797-1000	0.532±0.012 (13.50±0.30)	0.867±0.020 (22.00±0.50)	0.315±0.012 (8.00±0.30)	37	78
83-10-M637-1000	0.543±0.016 (13.77±0.40)	1.123±0.020 (28.50±0.46)	1.125±0.030 (28.57±0.76)	158	250
83-10-M12798-1000	0.552±0.012 (14.00±0.30)	0.867±0.020 (22.00±0.50)	0.394±0.012 (10.00±0.30)	42	84
83-10-M12772-1000	0.591±0.012 (15.00±0.30)	0.985±0.016 (25.00±0.40)	0.473±0.012 (12.00±0.30)	53	97
83-10-M12773-1000	0.630±0.016 (16.00±0.40)	1.103±0.024 (28.00±0.60)	0.512±0.012 (13.00±0.30)	63	112
83-10-M825-1000	0.749±0.020 (19.00±0.50)	1.143±0.030 (29.00±0.75)	0.295±0.010 (7.49±0.25)	31	75
83-10-M12774-1000	0.749±0.016 (19.00±0.40)	1.221±0.020 (31.00±0.50)	0.315±0.012 (8.00±0.30)	36	79
83-10-M12775-1000	1.079±0.024 (27.40±0.60)	1.599±0.032 (40.60±0.80)	0.591±0.016 (15.00±0.40)	55	106
83-10-M256-1000	1.418±0.0320 (36.00±0.75)	2.418±0.052 (61.40±1.30)	0.504±0.020 (12.80±0.50)	58	124

\*Based upon single turn impedance measurement, using an HP 4193A

# CHO-SORB® - Product Information

Figures 2 & 3  
FLAT SOLID CABLE CORE

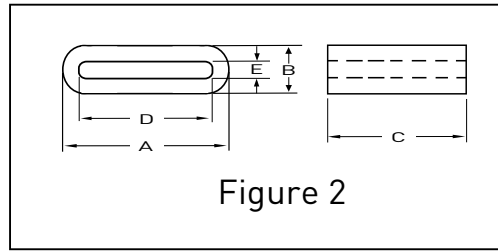

Figure 2

Table 3

Part Number	DIMENSIONS - inches (mm)					IMPEDANCE (ohms)	
	A	B	C	D	E	@ 25 MHz ±20%	@ 100 MHz ±20%
83-10-M12761-1000	0.63±0.016 (16.00±0.40)	0.197±0.138 (5.00±0.35)	0.315±0.016 (8.00±0.40)	0.453±0.016 (11.50±0.40)	0.02±.012 (0.50±0.30)	29	58
83-10-M12762-1000	1.122±0.04 (28.50±1.00)	0.256±0.012 (6.50±0.30)	0.315±0.016 (8.00±0.40)	0.925±0.02 (23.50±0.50)	0.034±.012 (0.85±0.30)	28	65
83-10-M12763-1000	1.22±0.04 (31.00±1.00)	0.197±0.012 (5.00±0.30)	0.472±0.012 (12.00±0.30)	1.063±0.028 (27.00±0.70)	0.034±.012 (0.85±0.30)	32	86
83-10-M12764-1000	1.312±0.04 (33.50±1.00)	0.256±0.012 (6.50±0.30)	0.472±0.012 (12.00±0.30)	1.063±0.028 (27.00±0.70)	0.055±0.016 (1.40±0.40)	30	66
83-10-M12765-1000	1.575±0.03 (40.00±0.70)	0.256±0.012 (6.50±0.30)	0.472±0.012 (12.00±0.30)	1.378±0.028 (35.00±0.70)	0.055±0.016 (1.40±0.40)	28	69
83-10-M12766-1000	1.78±0.04 (45.20±1.00)	0.256±0.012 (6.50±0.30)	0.472±0.012 (12.00±0.30)	1.575±0.028 (40.00±0.70)	0.055±0.016 (1.40±0.40)	28	68
83-10-M12767-1000	1.953±0.04 (49.60±1.00)	0.256±0.012 (6.50±0.30)	0.472±0.012 (12.00±0.30)	1.732±0.032 (44.00±0.80)	0.055±0.016 (1.40±0.40)	25	69
83-10-M12834-1000	2.268±0.039 (57.60±1.00)	0.756±0.012 (6.50±0.30)	0.472±0.012 (12.00±0.30)	2.047±0.032 (52.00±0.80)	0.055±0.016 (1.40±0.40)	26	75

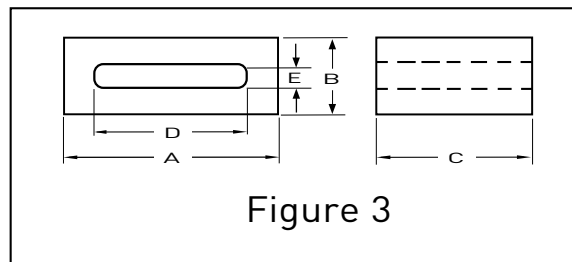

Figure 3

Table 3 continued

Part Number	DIMENSIONS - inches (mm)					IMPEDANCE (ohms)	
	A	B	C	D	E	@ 25 MHz ±20%	@ 100 MHz ±20%
83-10-M12768-1000*	2.362±0.04 (60.00±1.00)	0.472±0.016 (12.00±0.40)	0.5±0.016 (12.70±0.40)	1.91±0.032 (48.50±0.80)	0.087±0.012 (2.20±0.30)	40	104

# CHO-SORB® - Product Information

**Figure 4**  
**FLAT SPLIT CABLE CORE**

Impedance-Frequency Characteristics  
P/N 83-10-F255-1000

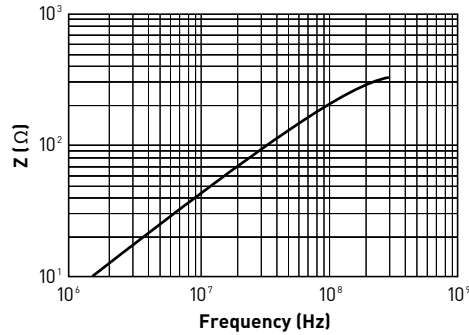
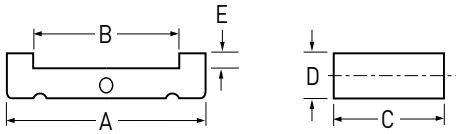

**Table 4**

Part Number	DIMENSIONS - inches (mm)					IMPEDANCE (ohms)	
	A	B	C	D	E	@ 25 MHz ±20%	@ 100 MHz -20%
83-10-F254-1000C	2.500 (63.5±1.3)	2.500 (52.1±1.1)	1.125 (28.57±0.8)	0.250 (6.35±0.25)	0.033 (0.84±0.2)	70	235
83-10-F255-1000C	3.000 (76.2±1.5)	2.570 (65.28±1.3)	1.125 (28.57±0.8)	0.250 (6.35±0.25)	0.033 (0.84±0.2)	60	215
83-10-M12769-1000C	1.50 (38.00±1.00)	1.05 (26.60±0.70)	1.00 (25.40±0.70)	0.250 (6.35±0.25)	0.033 (0.84±0.2)	105	175
83-10-M12770-1000C	1.775 (45.00±1.00)	1.355 (34.40±0.70)	1.125 (28.50±0.70)	0.250 (6.35±0.25)	0.033 (0.84±0.2)	102	189
83-10-M12771-1000C	2.17 (55.10±1.20)	1.72 (43.70±1.00)	1.125 (28.50±0.70)	0.250 (6.35±0.25)	0.033 (0.84±0.2)	80	181

**Figure 5**  
**CLIPS FOR FLAT SPLIT CABLE CORE**

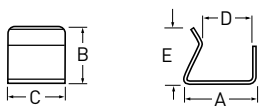

Material: 0.020 inch (0.5 mm) High Carbon Steel  
Finish: Zinc Electroplate

**Table 5**

Part Number	DIMENSIONS - inches (mm)					Fits CHO-SORB Part Number
	A	B	C	D	E	
83-10-C0005-1000	0.618 (15.7)	0.280 (7.1)	0.500 (12.7)	0.457 (11.6)	0.382 (9.7)	83-10-F254-1000C 83-10-F255-1000C 83-10-M12769-1000C 83-10-M12770-1000C 83-10-M12771-1000C

# CHO-SORB® - Product Information

**Figure 6**  
**SQUARE SPLIT BEAD ASSEMBLY**

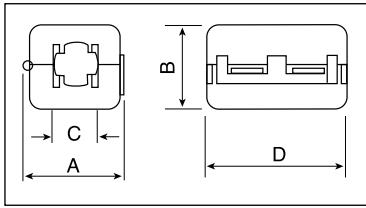

Case Material: Nylon 6/6,  
Flammability Rating: UL 94V-2

**Table 6**

Part Number	DIMENSIONS - inches (mm)					IMPEDANCE (ohms)	
	A	B	C	D	E	@ 25 MHz ±20%	@ 100 MHz ±20%
83-10-Y377-1000	1.24±0.04 (31.50±1.00)	1.22±0.04 (31.00±1.00)	0.55±0.04 (14.00±1.00)	1.28±0.04 (32.50±1.00)	0.512 (13.00)	137	268
83-10-Y379-1000	0.80±0.04 (20.50±1.00)	0.79±0.04 (20.10±1.00)	0.30±0.04 (7.60±1.00)	1.28±0.04 (32.50±1.00)	0.256 (6.50)	133	308
83-10-Y850-1000	1.00±0.04 (25.50±1.00)	0.925±0.04 (23.50±1.00)	0.453±0.04 (11.50±1.00)	1.28±0.04 (32.50±1.00)	0.394 (10.00)	124	245
83-10-M12818-1000	0.59±0.04 (15.00±1.0)	0.55±0.04 (14.00±1.0)	0.236±0.04 (6.00±1.00)	0.906±0.04 (23.00±1.0)	0.197 (5.00)	103	174

**Figure 7 & 8**  
**ROUND SPLIT BEAD ASSEMBLY**

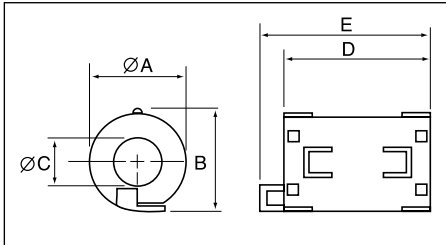

Fig. 7

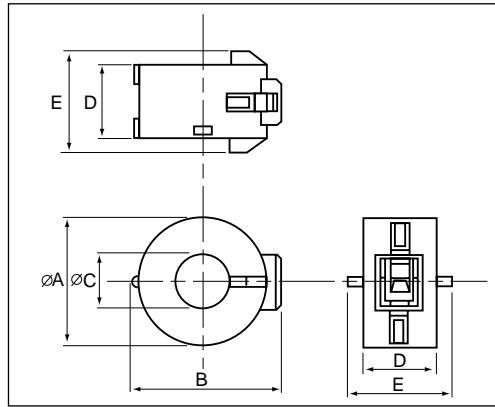

Fig. 8

Case Material: Nylon 6/6,  
Flammability Rating: UL 94V-2

**Table 7**

Part Number	Figure	DIMENSIONS - inches (mm)					Max. Cable Gauge	IMPEDANCE (ohms)	
		A (dia)	B	C (dia)	D	E		@ 25 MHz ±20%	@ 100 MHz ±20%
83-10-M12799-1000	1	0.77±0.04 (19.5±1.0)	0.81±0.04 (20.5±1.0)	0.39±0.04 (10.0±1.0)	1.24±0.04 (31.5±1.0)	1.40±0.04 (35.5±1.0)	0.35 (9mm)	120	190
83-10-M12813-1000	2	0.77±0.04 (19.5±1.0)	0.91±0.04 (23.0±1.0)	0.33±0.04 (8.5±1.0)	0.67±0.04 (17.0±1.0)	0.91±0.04 (23.0±1.0)	0.31 (8mm)	60	120
83-10-M12814-1000	2	0.77±0.04 (19.5±1.0)	0.91±0.04 (23.0±1.0)	0.32±0.04 (8.2±1.0)	0.79±0.04 (20.0±1.0)	1.02±0.04 (26.0±1.0)	0.31 (8mm)	75	160
83-10-M12815-1000	2	0.96±0.04 (24.5±1.0)	1.12±0.04 (28.5±1.0)	0.39±0.04 (10.0±1.0)	0.53±0.04 (13.5±1.0)	0.79±0.04 (20.0±1.0)	0.39 (10mm)	50	105
83-10-M12816-1000	2	1.10±0.04 (28.0±1.0)	1.24±0.04 (31.5±1.0)	0.45±0.04 (11.5±1.0)	0.71±0.04 (18.0±1.0)	0.94±0.04 (24.0±1.0)	0.43 (11mm)	70	140
83-10-M12817-1000	2	1.14±0.04 (29.0±1.0)	1.30±0.04 (33.0±1.0)	0.55±0.04 (14.0±1.0)	0.61±0.04 (15.5±1.0)	0.85±0.04 (21.5±1.0)	0.55 (14mm)	45	100

[www.chomerics.com](http://www.chomerics.com)  
[www.parker.com/chomerics](http://www.parker.com/chomerics)

CHOMERICS and CHO-SORB is a registered trademark of Parker Hannifin Corporation. © 2013

TB 1089 EN April 2013